

500 MOUNT SERIES: 516

Dimensions & Performance Characteristics

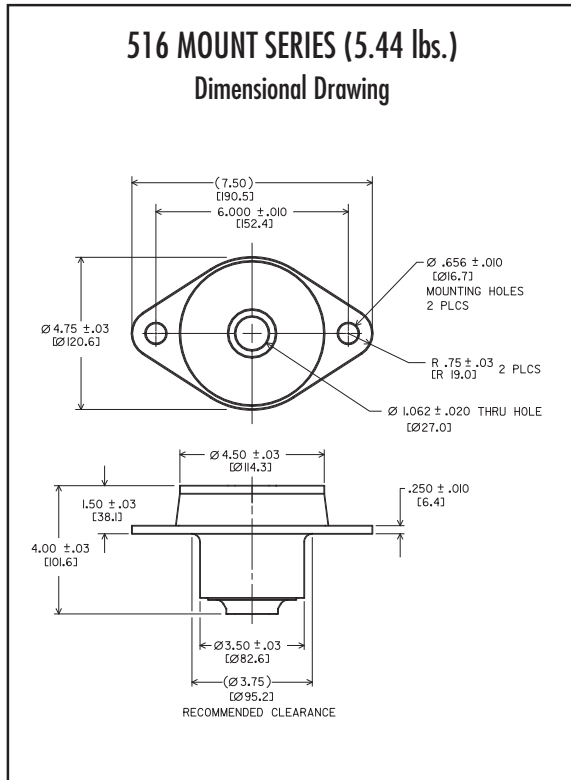

516 SERIES LOAD RANGE (lbs.)					COLOR CODE
Code	Axial Static Load Range		Radial Static Load Range		
	Nominal	Max.	Nominal	Max.	
-1	830	1245	415	830	Red & White
-2	1000	1500	500	1000	Orange & White
-3	1210	1815	605	1210	Yellow & White
-4	1470	2205	735	1470	Green & White
-5	1780	2700	890	1780	Blue & White

