

500 MOUNT SERIES: 508

Dimensions & Performance Characteristics

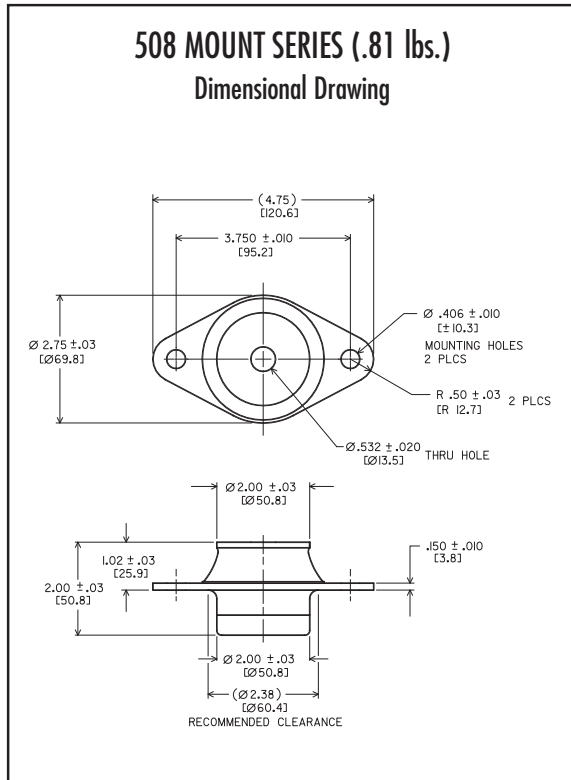

Code	508 SERIES LOAD RANGE (lbs.)				COLOR CODE
	Axial Static Load Range		Radial Static Load Range		
	Nominal	Max.	Nominal	Max.	
-1	180	270	90	180	Red & White
-2	220	330	110	220	Orange & White
-3	260	390	130	260	Yellow & White
-4	320	480	160	320	Green & White
-5	380	570	190	380	Blue & White

